

GENERAL

BEFORE BEGINNING

- A. Convene one week prior to commencing work of this section.
- B. Require attendance of installation material manufacturer, tile supplier, tile installer and installers of related work. Review installation procedures and coordination required with related work.
- C. Meeting agenda includes but is not limited to:
 1. Stone tile and installation material compatibility.
 2. Grouting procedure.
 3. Maintenance and cleaning products and methods.
 4. Surface Preparation.

DELIVERY, STORAGE AND HANDLING

- A. Deliver and store packaged materials in original containers with seals unbroken and labels intact until time of use. Prevent damage or contamination to materials by water, freezing, foreign matter or other causes.
- B. Protect setting materials from freezing or overheating in accordance with manufacturer's instructions.
- C. Store tile and setting materials on elevated platforms, under cover and in a dry location and protect from contamination, dampness, freezing or overheating.
- D. Do not use frozen materials unless specifically allowed by manufacturer.
- E. Deliver and store materials on site at least 24 hours before work begins.
- F. Provide heated and dry storage facilities on site.

ENVIRONMENTAL REQUIREMENTS

- A. Maintain environmental conditions and protect work during and after installation to comply with referenced standards and manufacturer's printed recommendations.
- B. Vent temporary heaters to exterior to prevent damage to tile work from carbon dioxide buildup.
- C. Maintain temperatures at not less than 50 deg. F (10 deg. C) in tiled areas during installation and for 7 days after completion, unless higher temperatures are required by referenced installation standards or manufacturer's written instructions.

ADHESIVES AND PRIMERS

- A. Multi-Purpose Bond-Promoting Primer: Low-VOC, synthetic resin-based primer with bondpromoting silica aggregates suspended in a dispersion, for interior and exterior applications.
 1. Product: Subject to compliance with requirements, provide MAPEI, ECO Prim Grip.
- B. Adhesive Bond Coat for Sound Reduction Membrane: Light tan, nonflammable and CRI (Green Label Plus certified) adhesive;
 1. Product: Subject to compliance with requirements, provide MAPEI, Ultrabond ECO 420.
 2. Applications: Interior floors for the installation of recycled rubber sound reduction membrane

GROUT MATERIALS

- A. High Performance Cement Tile Grout: For grout joints from 1/16 inch to 3/4 inch (1.5 mm to 19 mm) and meeting ANSI A118.7 and ISO 13007 CGWAF.
 1. Product: Subject to compliance with requirements, provide MAPEI, Ultracolor Plus FA.
- B. Polymer Ready-to-Use Tile Grout for grout joints from 1/16 inch to 1/2 inches (1.5 mm to 12 mm).
 1. Product: Subject to compliance with requirements, provide MAPEI, MAPEI Ultralite S2.

+1 (310) 341-6931

+1 (323) 538-3630

WWW. BORROWEDEARTHCOLLABORATIVE.COM

INFO@ BORROWEDEARTHCOLLABORATIVE.COM

WATERPROOF MEMBRANE

- A. General: Manufacturer's standard product that complies with ANSI A118.10 and is recommended by the manufacturer for the application indicated. Include reinforcement and accessories recommended by manufacturer
- Product: Subject to compliance with requirements, provide MAPEI materials.
- B. Fluid-Applied Membrane: Liquid-latex rubber or elastomeric polymer
- Product: Subject to compliance with requirements, provide MAPEI, Mapelastastic AquaDefense.
- B. Latex-Portland Cement: Flexible mortar consisting of cement-based mix and latex additive.
- Product: Subject to compliance with requirements, provide MAPEI, "Mapelastastic 315".

FLEXIBLE SEALANT

- A. Professional-grade, 100%-silicone sealant specifically formulated for heavy traffic expansion and movement joints, horizontal and vertical complying with ASTM standards; slump (ASTM C639), tack-free time (ASTM C879), shore "A" hardness (ASTM C661), joint movement (ASTM C920), elongation at break (ASTM D412), flexibility (ASTM C734) and passes weatherability (Accelerated Weathering Tester QUV).
- Product: Subject to compliance with requirements, provide MAPEI, Mapesil T.
 - Product: Subject to compliance with requirements, provide MAPEI, Mapesil 3D.

SOUND REDUCTION MEMBRANE

- A. Sound Control and Crack Isolation; Flexible, thin, load-bearing, recycled rubber soundreduction and crack isolation membrane complying with ANSI A118.12:
- Product: Subject to compliance with requirements, provide MAPEI, Mapesonic RM.
 - Mapesonic RM 5: 5mm thickness for sound reduction.
 - Mapesonic RM 10: 10mm thickness for improved sound reduction.

PENETRATING TILE AND STONE SEALERS

- A. Solvent-based penetrating sealer; premium, natural-look, that uses VOC-exempt materials and will provide maximum protection on interior and exterior natural stone (marble, limestone, sandstone, slate, granite, travertine, etc.), unglazed and porcelain ceramic tile, masonry and grout. Can be used as a pre-grouting sealer (grout-release); MAPEI, UltraCare Penetrating Plus SB Stone & Porcelain Tile Sealer.
- B. Economical color-enhancing penetrating sealer that enhances the natural colors of stone and provides protection on all interior and exterior natural stone surfaces such as, marble, limestone, sandstone, slate,
- granite, travertine, as well as cementitious grout. Can be used as a pre-grouting sealer (grout-release); MAPEI, UltraCare Enhancing Stone Sealer.
- C. Premium color-enhancing penetrating sealer that enhances the natural colors of stone and provides maximum protection. Safe for use on all interior and exterior natural stone surfaces, such as marble, limestone, sandstone, slate, granite, travertine as well as cementitious grout. The product can also be used as a pre-grouting sealer; MAPEI, UltraCare Enhancing Plus Stone Sealer.

TOPICAL STONE SEALER AND FINISHES

- A. High-Sheen, one-step, non-yellowing, resistant to ultraviolet light, water-based formula that provides a durable high-gloss finish and maximum stain resistance for interior uses, and can also be used as a pre grouting sealer (grout release); MAPEI, UltraCare High Gloss Sealer & Finish.
- B. Low-Sheen, one-step, non-yellowing, water-based formula that provides a durable lowsheen satin finish and maximum stain resistance. This product can also be used as a pregrouting sealer. For interior and exterior use, is non-yellowing and resistant to ultraviolet light; MAPEI, UltraCare Low-Sheen Stone Sealer & Finish.

+1 (310) 341-6931

+1 (323) 538-3630

WWW. BORROWEDEARTHCOLLABORATIVE.COM

INFO@ BORROWEDEARTHCOLLABORATIVE.COM

TILE AND STONE MAINTENANCE, CLEANERS AND GROUT HAZE REMOVERS

- A. Stone cleaner and polish for kitchen and bathroom countertops, and is non-acidic; MAPEI, UltraCare Everyday Stone Clean & Polish.
- B. High-alkaline cleaner; highly concentrated and degreaser that quickly removes waxes, grease, oil, light soap scum, mildew and algae stains. For areas that have been neglected or subject to heavy use; MAPEI, UltraCare Heavy-Duty Stone, Tile & Grout Cleaner.
- C. Stain remover for stone; absorbs food, grease and oil stains out of natural-stone surfaces including granite, marble, limestone, slate, travertine, terra cotta, flagstone, concrete and cement grout; MAPEI, UltraCare Deep Stain Remover for Stone.

MIXES

- A. Proportion and mix materials in accordance with manufacturer's most current written instructions and applicable ANSI standards.

EXECUTION

EXAMINATION

- A. Examine surfaces to receive tilework and conditions under which tile will be installed.
- B. Do not proceed with tilework until surfaces and conditions comply with requirements indicated in reference tile installation standard and manufacturer's printed instructions.
- B. When underlayment, patching, leveling and rendering materials are needed, they must be from the supplier of the setting materials. For improved warranty and single source responsibility.

INSTALLATION

- A. Install tile in accordance with manufacturer's printed instructions and the applicable requirements of ANSI A108 Series for the materials being used.
- B. Install stone tile using TCNA methods and NSI guidelines.
- B. Install expansion and control joints in accordance with TCNA method EJ171.
- C. Apply stone tile and grout cleaners, sealers and maintenance products in accordance with manufacturer's printed instructions and technical data sheets.

GROUTING

- A. Grout joints in accordance with manufacturer's instructions and ANSI A108.10.
- B. Remove standing water, dust, and foreign substances from joints to be grouted.
- C. Clean and dry stone tile surfaces.
- D. Due to the irregular joints, bag grout into the joints or apply sealant
- E. After grouting, remove all grout residue promptly.

PROTECTION

- A. Walls: Protect from impact, vibration and heavy hammering on adjacent and opposite walls for at least 14 days after installation, unless manufacturer's instructions allow a shorter period.
- B. Protect from weather which can cause staining for at least 14 days.
- C. Protect from freezing and total water immersion for at least 21 days after installation.

+1 (310) 341-6931

+1 (323) 538-3630

WWW. BORROWEDEARTHCOLLABORATIVE.COM

INFO@ BORROWEDEARTHCOLLABORATIVE.COM

TYPICAL CORNER DETAILS

MITER

Any condition of stone veneer, coping, paving strips, etc, where a corner condition is accomplished by two stones with angular cuts, with the angles of the cuts being equal to the bisection of the total angle. See also quirk miter.

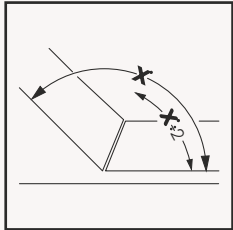

QUIRK MITER

An external corner formed by two stone panels with beveled (usually 45°) edges and blunted, finished noses to reduce the chipping vulnerability of the sharp edges that occur with a common miter.

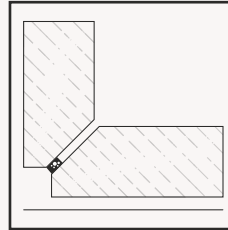

OUTSIDE CORNER MITERING

CIRCULAR SAW METHOD

STEP 1: With a T-square, mark the back of the panel where the cut is to be made. Before cutting the panel, look on the texture side to make sure that when the cut is made that the stones are balanced and you are not going to cause any unusually small stone patterns in the corner miter.

STEP 2: It is recommended that you use a clamp on saw guide to ensure that the cut is uniformly straight for a tight fit.

STEP 3: Cut a 45° angle on both sides of the cut line (a triangular piece will be the bi-product of the cuts.)

STEP 4: For exterior applications a polyurethane adhesive is required where the two mitered corners come together (not caulk) followed by a few screws to reinforce the corner.

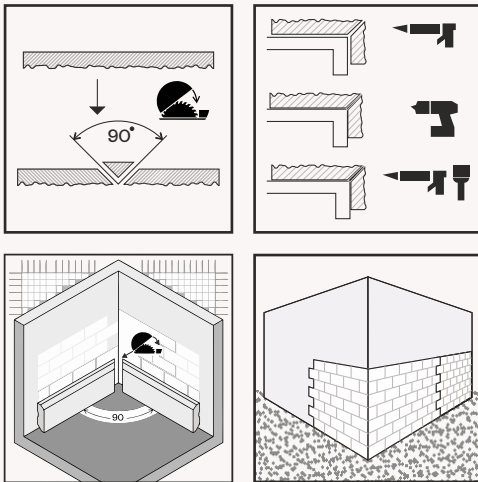

INSIDE CORNER MITERING

The recommended methods for cutting the panels can be seen in the diagrams shown. Figure 9.2B—Using a circular saw. Figure 9.2C—Using a table saw.

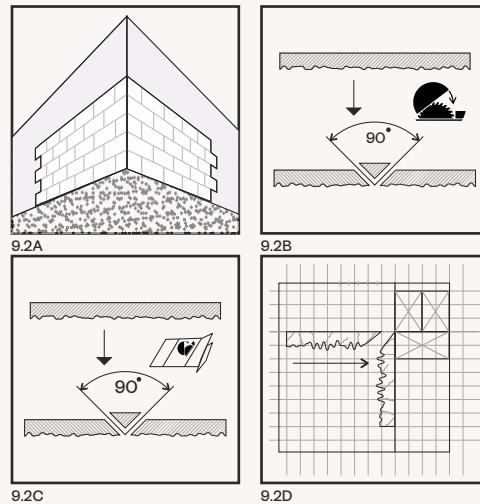

*Note: Please Refer to TCNA Guidelines

INTERIOR WALLS OVER MASONRY OR CONCRETE

Masonry or Concrete • Bonded Mortar Bed • Natural Stone Tile

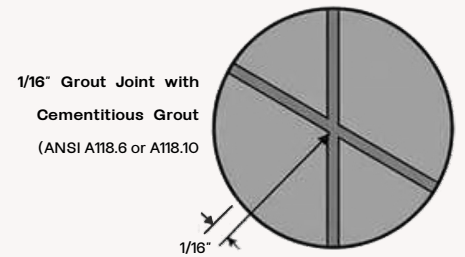
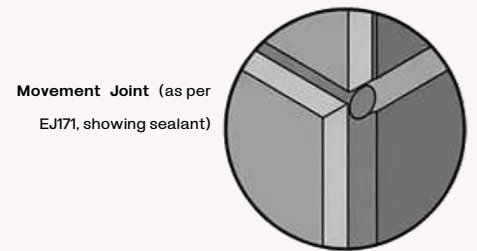
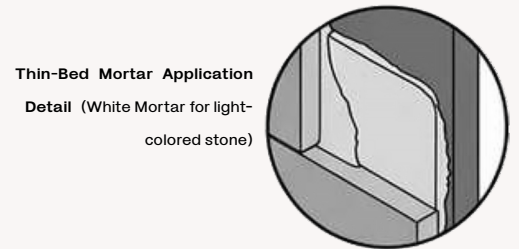
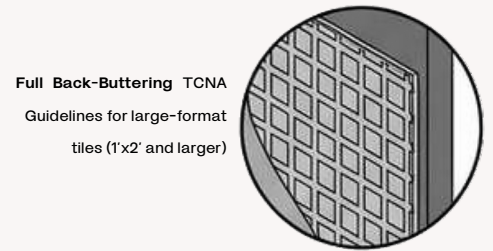
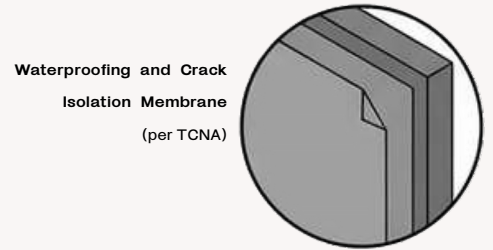
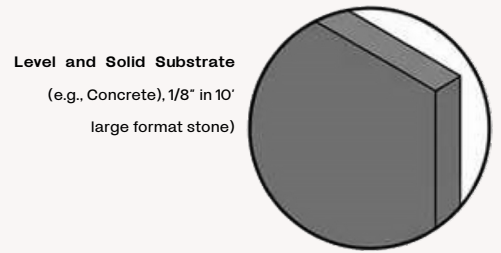
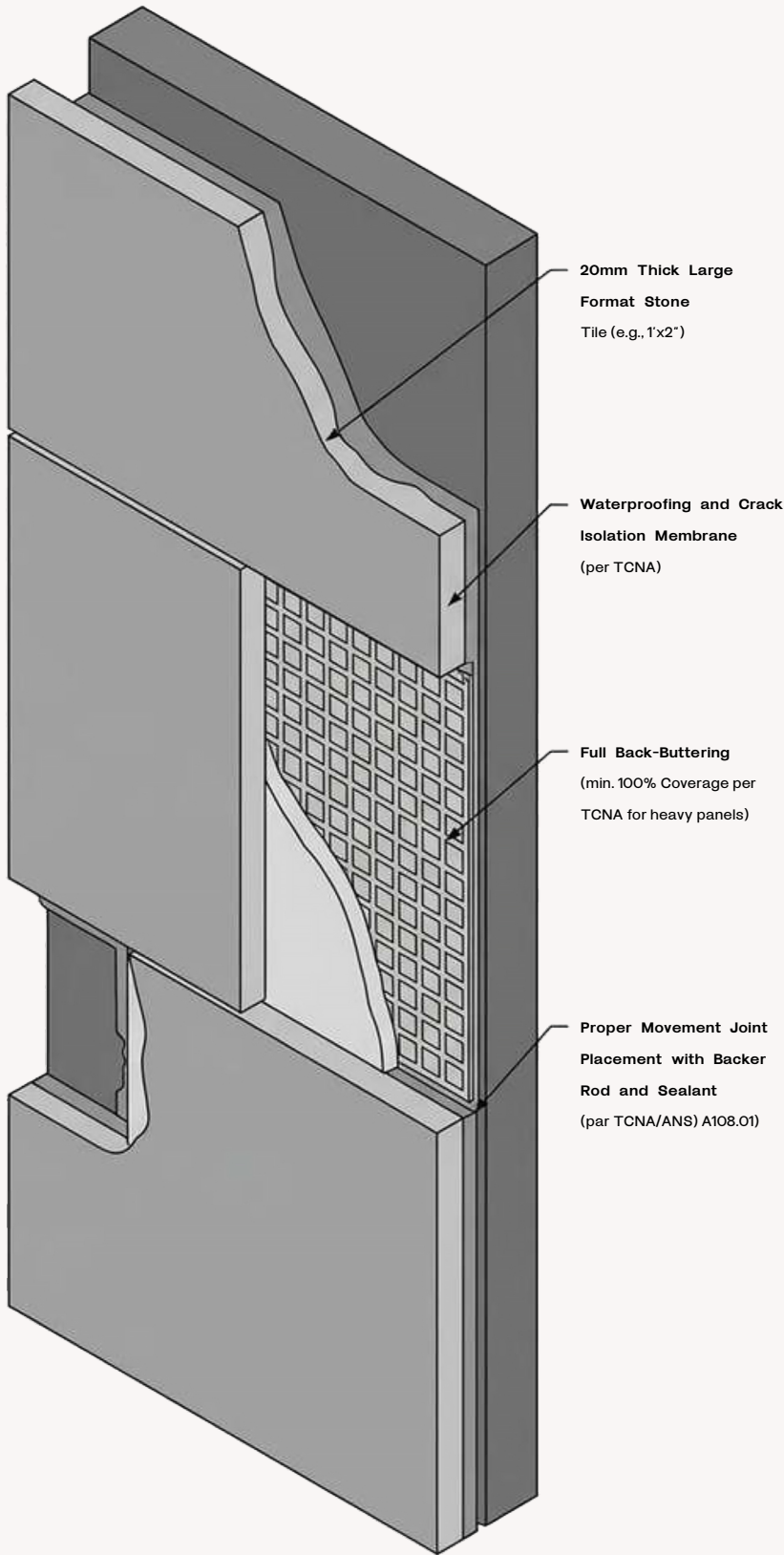

Source: 2019 Tile Council of North America

INTERIOR WALLS OVER MASONRY OR CONCRETE

Masonry or Concrete • Spot-Bonding Epoxy • Natural Stone Tile

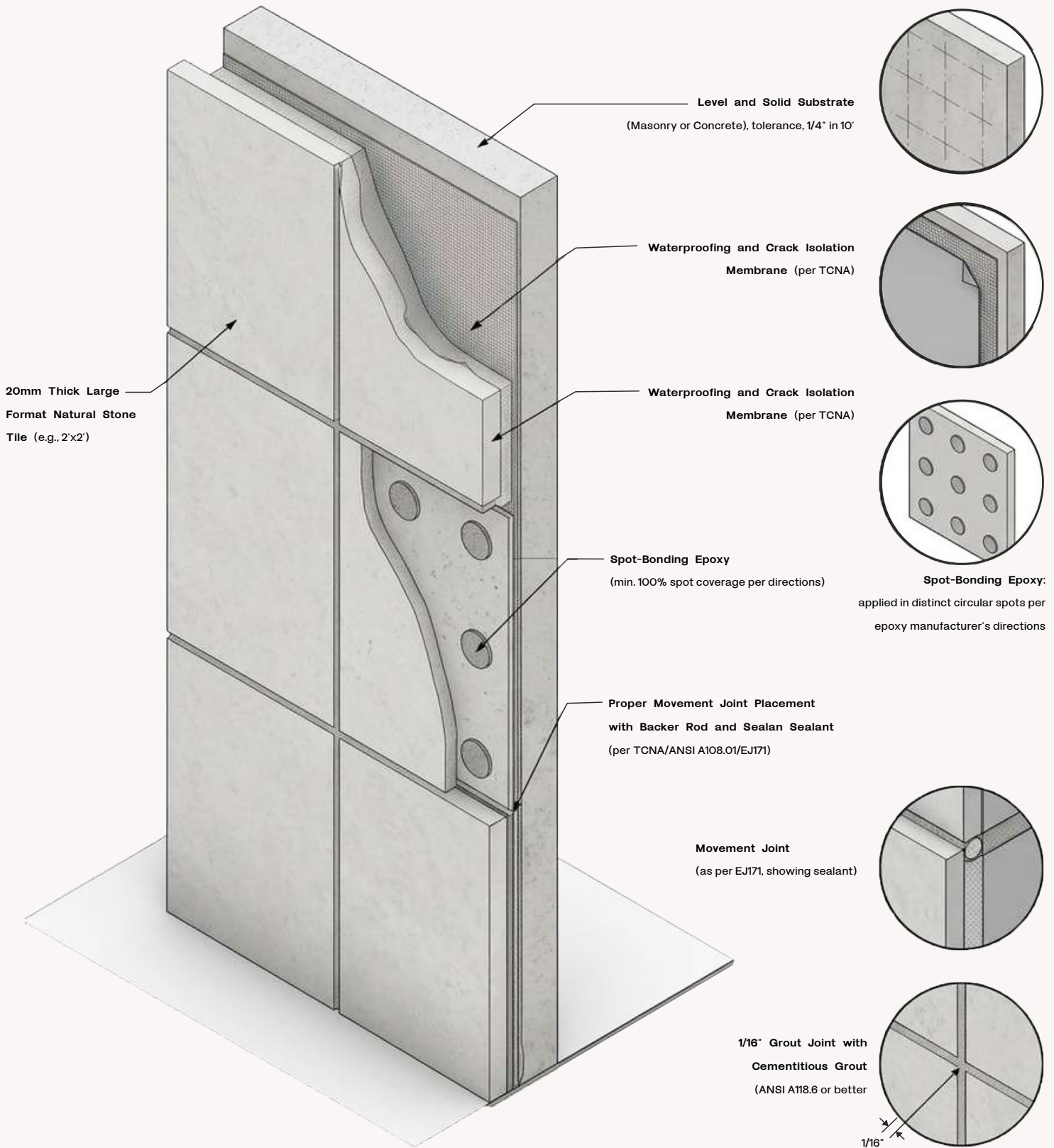

Source: 2019 Tile Council of North America

INTERIOR WALLS OVER MASONRY OR CONCRETE

Masonry or Concrete • Natural Stone Tile

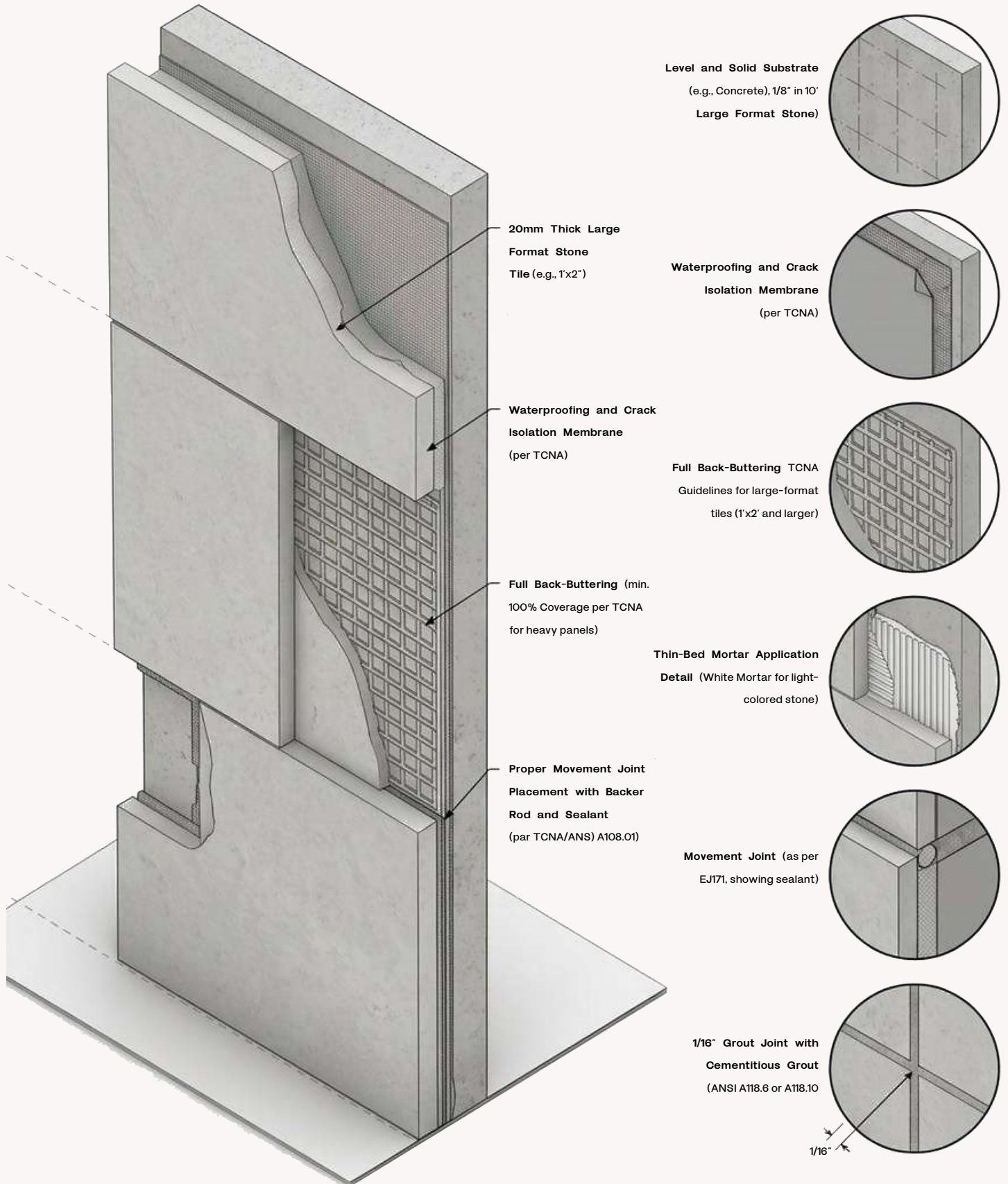

Source: 2019 Tile Council of North America

INTERIOR WALLS OVER SOLID BACKING

Solid Backing • Mortar Bed • Natural Stone Tile

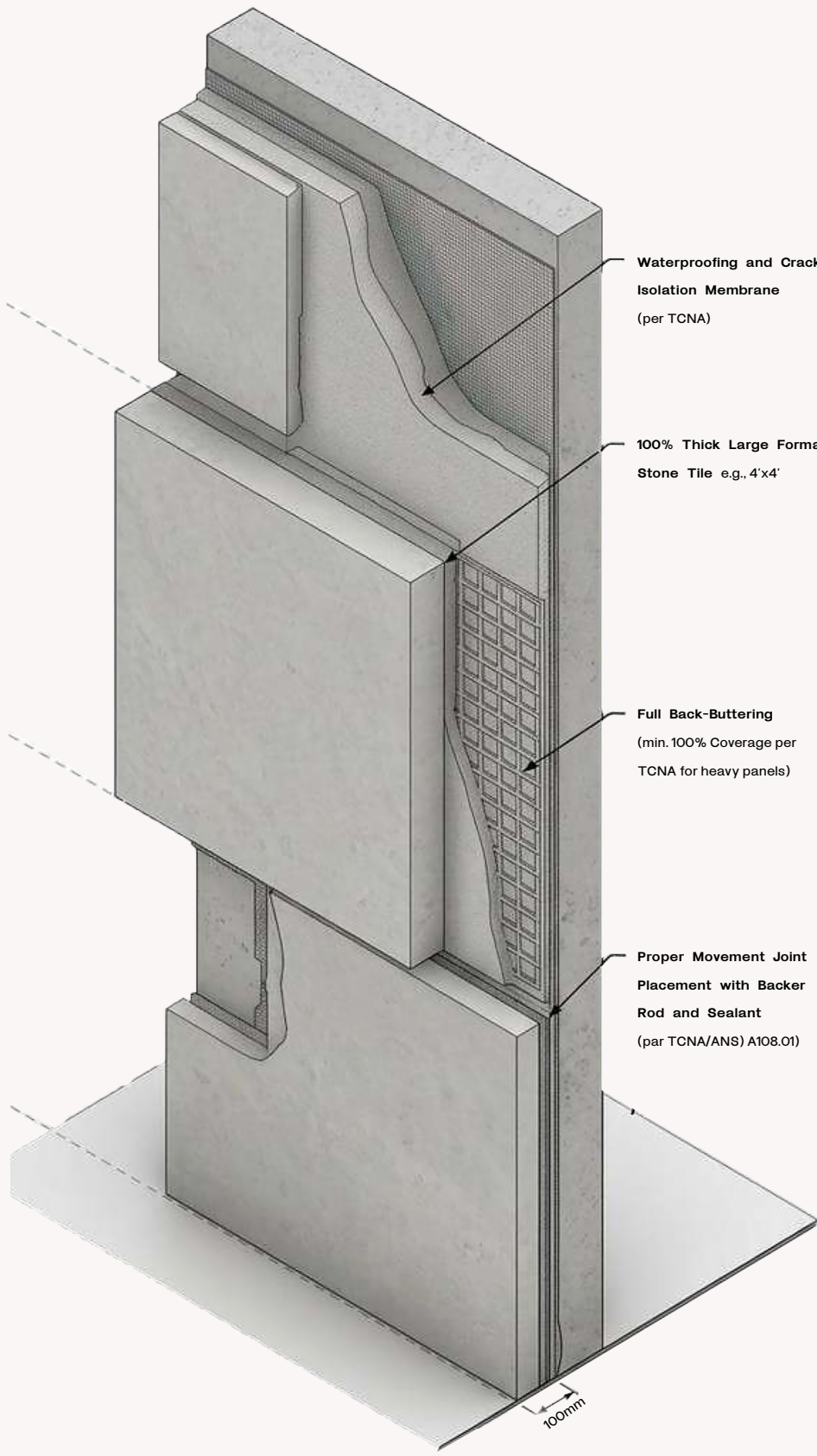

Level and Solid Substrate
 (e.g., Concrete), 1/8" in 10'
 Large Format panels

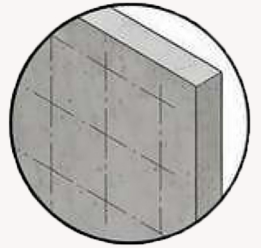

Waterproofing and Crack Isolation Membrane
 (per TCNA)

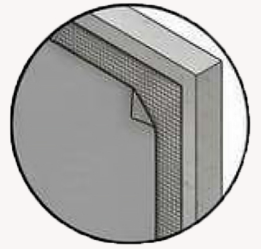

Waterproofing and Crack Isolation Membrane
 (per TCNA)

100% Thick Large Format Stone Tile e.g., 4'x4'

Full Back-Buttering TCNA
 Guidelines for large-format tiles (1'x2', 4'x4' and larger)

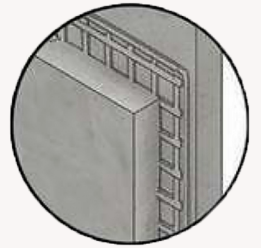

Full Back-Buttering
 (min. 100% Coverage per TCNA for heavy panels)

Thin-Bed Mortar Application Detail (White Mortar for light-colored stone)

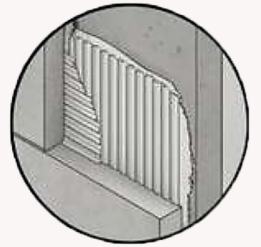

Proper Movement Joint Placement with Backer Rod and Sealant
 (par TCNA/ANSI A108.01)

Movement Joint
 (as per EJ171, showing sealant)

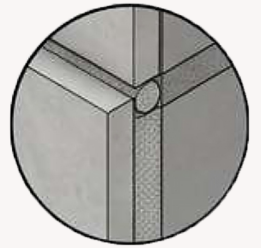

1/16" Grout Joint with Cementitious Grout
 (ANSI A118.6 or A118.10)

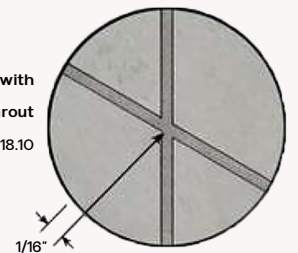

Source: 2019 Tile Council of North America

INTERIOR WALLS OVER SOLID BACKING

Solid Backing • Mortar Bed • Natural Stone Tile • Mechanical Anchoring

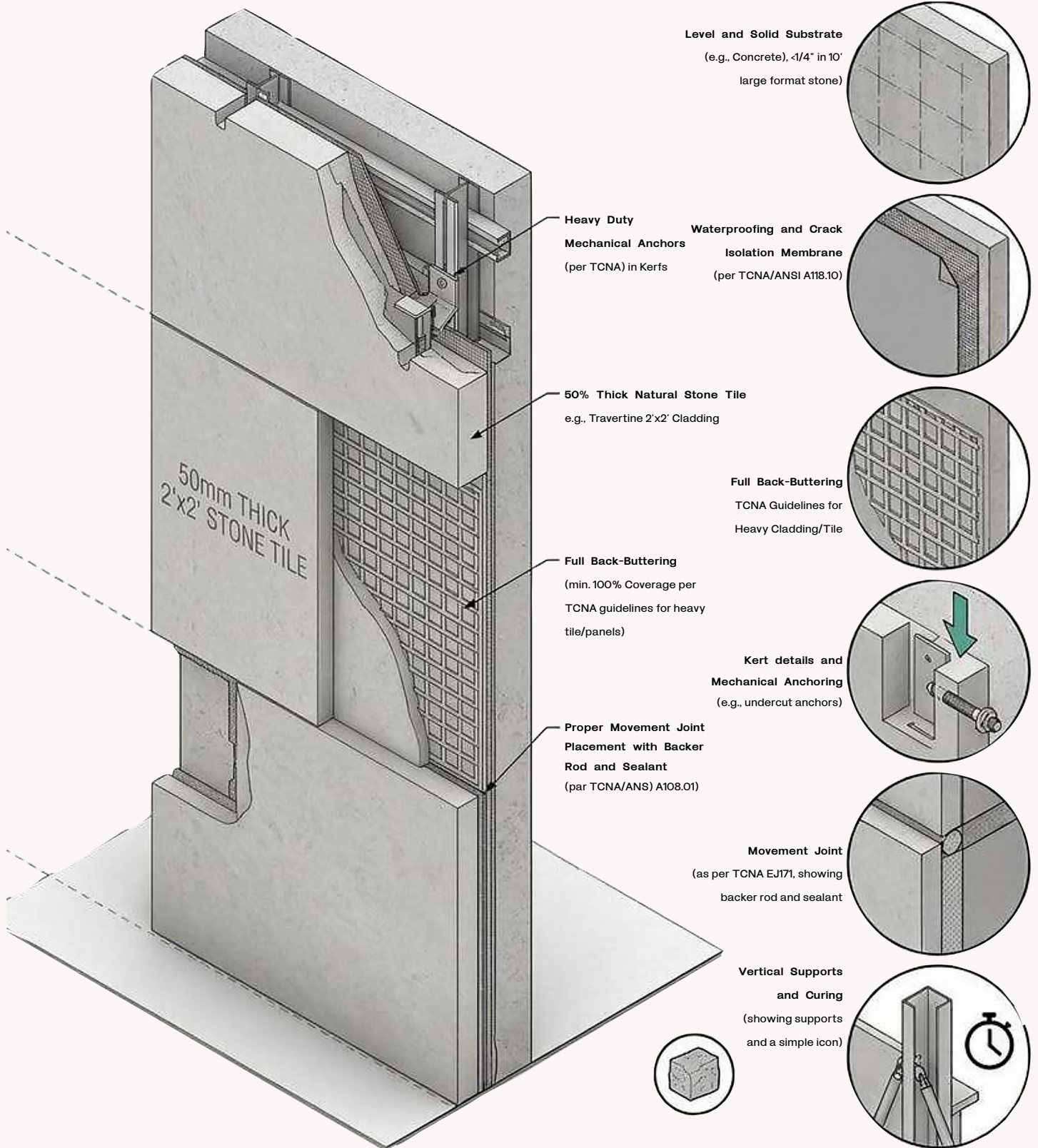

INTERIOR WALLS OVER WOOD OR METAL STUDS

Wood or Metal Studs • Mortar Bed • Natural Stone Tile

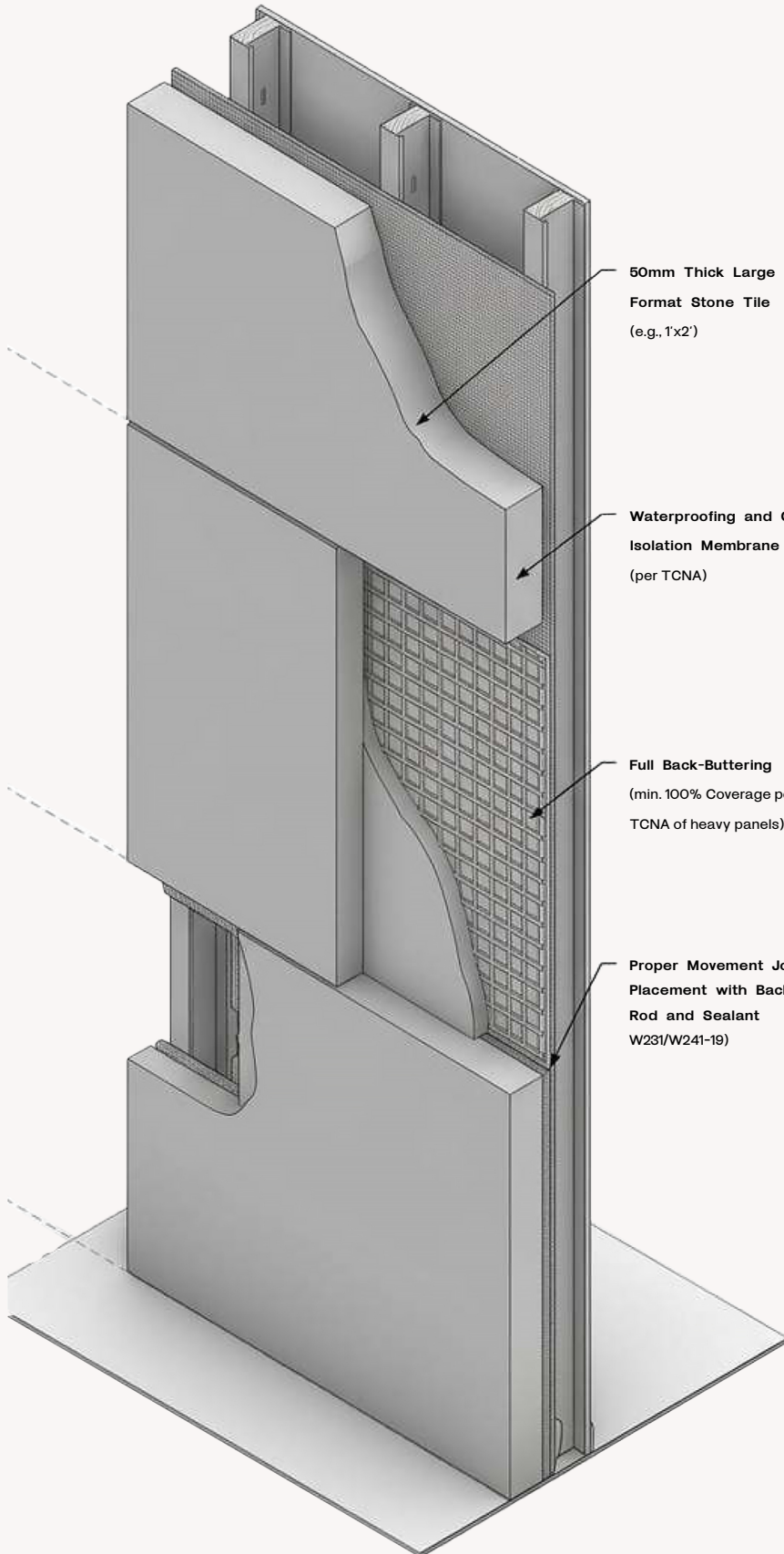

Level and Solid Substrate
(Concrete or Plywood 1/8" in
10' large format stone)

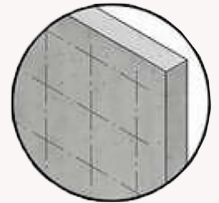

Metal Stud Furring
(per ASMT C645, min. 20ga.)

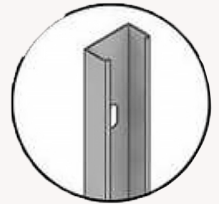

**Water-Resistive Barrier/
Vapor Retarder**
(ANSI A108.02-3.8)

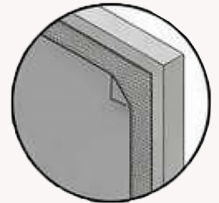

Full Back-Buttering
(min. 100% Coverage per
TCNA of heavy panels)

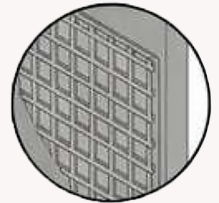

Waterproofing Membrane
(ANSI A118.10)

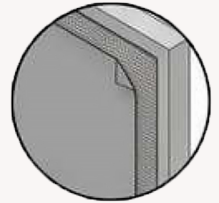

Proper Bonding Mortar
(White for light stone,
ANSI A118.4/A118.15)



Movement Joint
(per TCNA EJ171, with
backer rod & sealant)

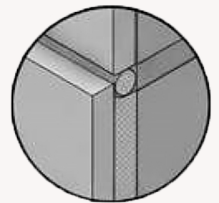

1/16" Grout Joint
(Cementitious, ANSI A118.6)

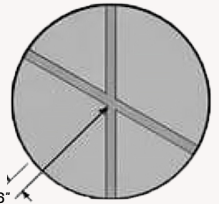

Source: 2019 Tile Council of North America

INTERIOR WALLS OVER WOOD OR METAL STUDS

Wood or Metal Studs • Mortar Bed • Natural Stone Tile

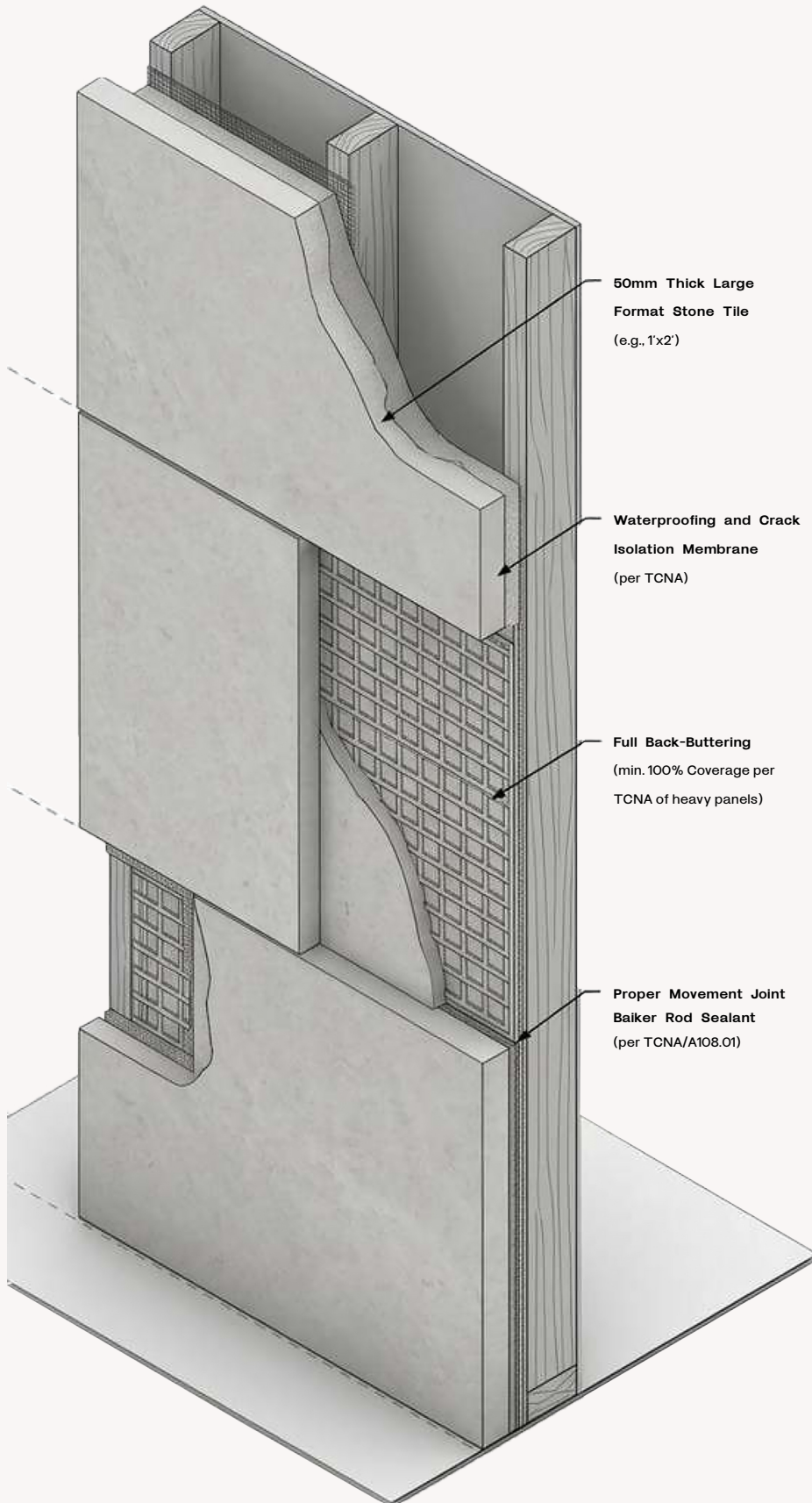

Level and Solid Substrate
 (e.g., Wood Studs/Mortar Bed),
 1/8" in 10' large format stone)

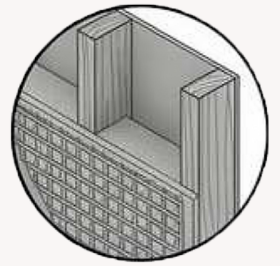

Waterproofing and Crack Isolation Membrane
 (per TCNA)

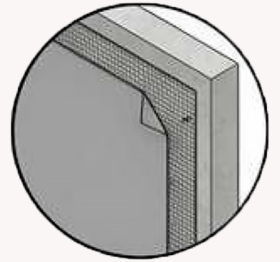

Full Back-Buttering TCNA
 Guidelines for large-format
 tiles (1'x2' and larger)

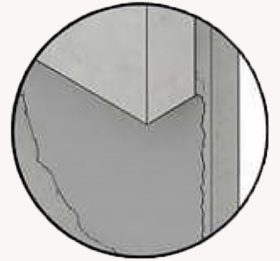

50mm Thick Large Format Stone Tile
 (e.g., 1'x2')

Waterproofing and Crack Isolation Membrane
 (per TCNA)

Full Back-Buttering
 (min. 100% Coverage per
 TCNA of heavy panels)

Proper Movement Joint
Balke Rod Sealant
 (per TCNA/A108.01)

Thin-Bed Mortar Application Detail
 (White Mortar for light-colored stone)

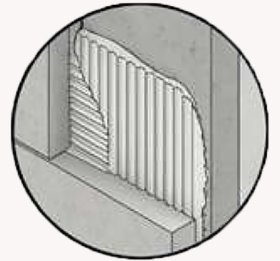

Movement Joint (as per
 EJ171, showing sealant)

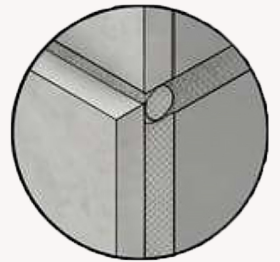

1/16" Grout Joint with Cementitious Grout
 (ANSI A118.6 or A118.10)



Source: 2019 Tile Council of North America

INTERIOR WALLS OVER WOOD OR METAL STUDS

Wood or Metal Studs • Gypsum Board • Natural Stone Tile

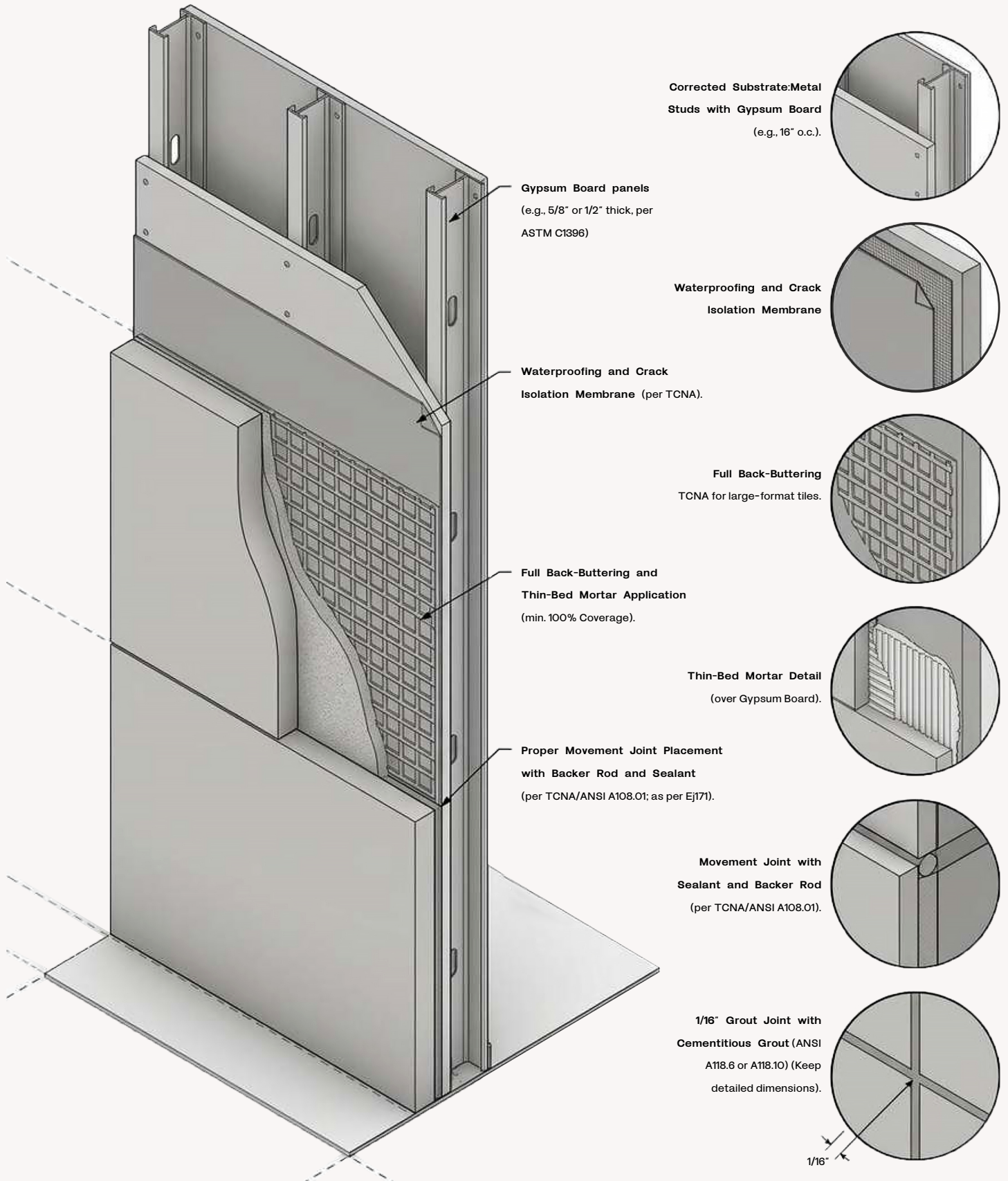

Source: 2019 Tile Council of North America

INTERIOR WALLS OVER WOOD OR METAL STUDS

Wood or Metal Studs • Cement Backer Board • Natural Stone Tile

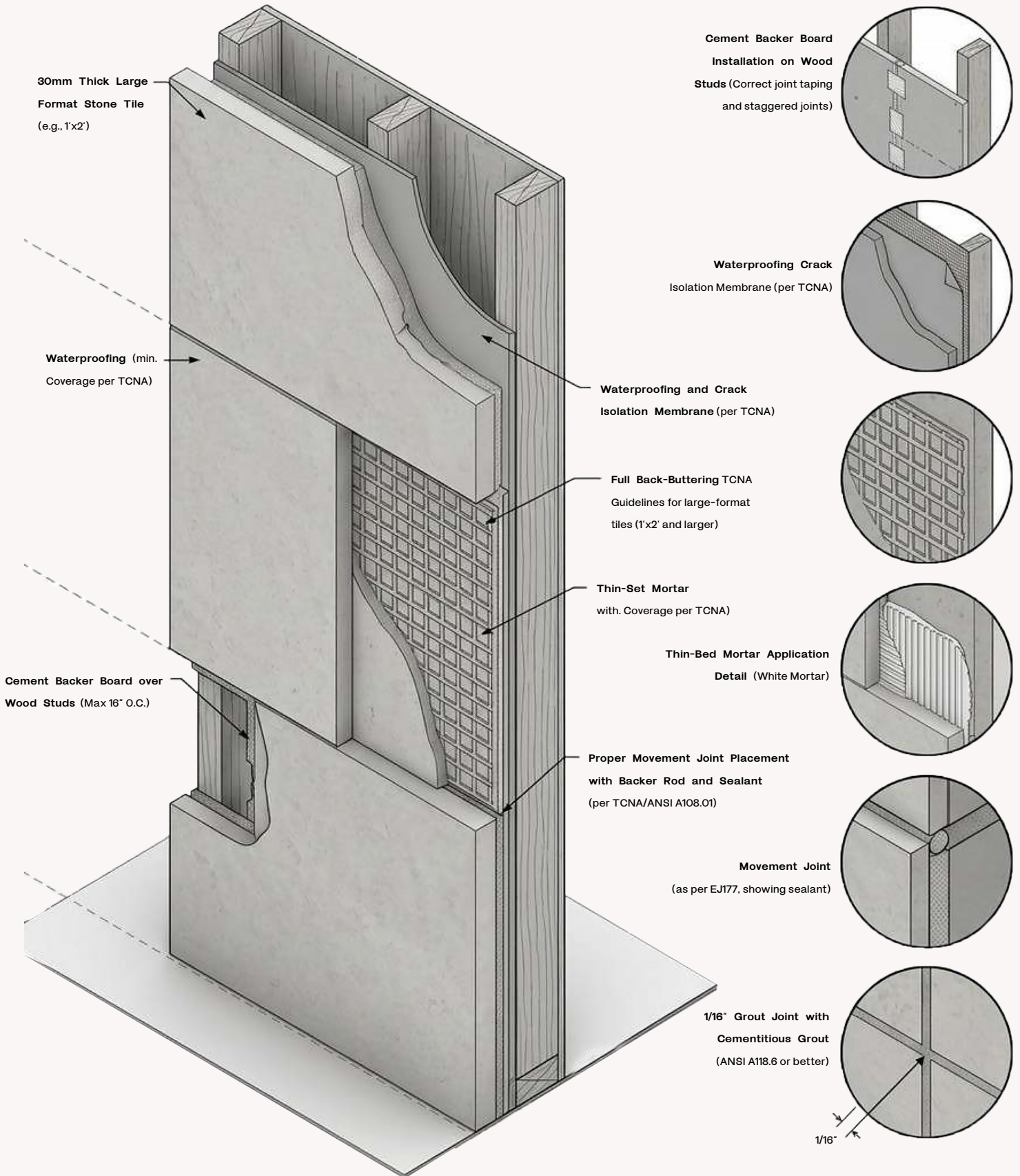

Source: 2019 Tile Council of North America

+1 (310) 341-6931

+1 (323) 538-3630

WWW. BORROWEDEARTHCOLLABORATIVE.COM

INFO@ BORROWEDEARTHCOLLABORATIVE.COM

INTERIOR WALLS OVER WOOD OR METAL STUDS

Wood or Metal Studs • Gypsum Backer Board • Natural Stone Tile

- Wood Studs | • Coated Glass Mat Water-Resistant Gypsum
- Backer Board-Board • Natural Stone Tile

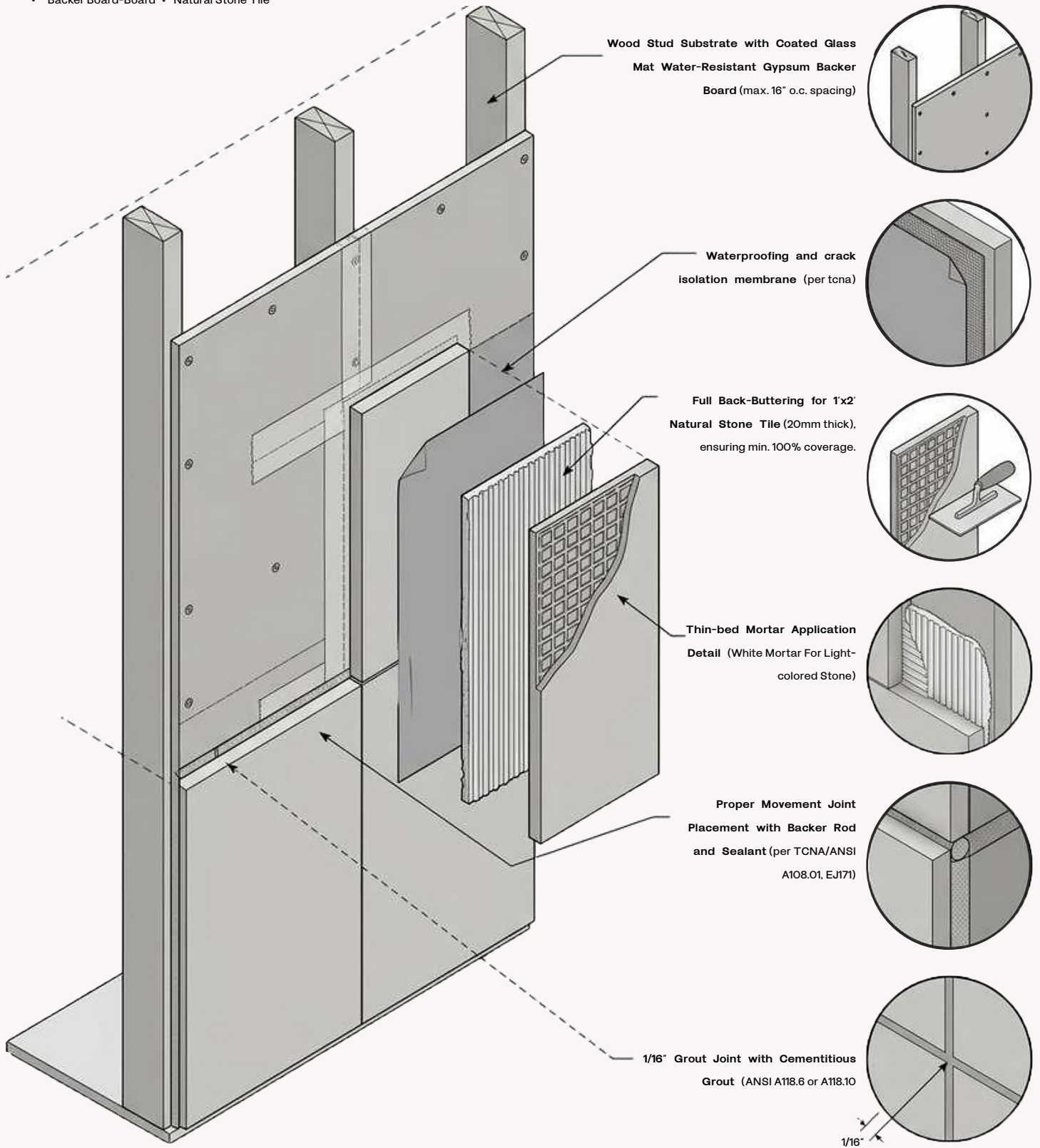

Source: 2019 Tile Council of North America

borrowed earth

+1 (310) 341-6931

+1 (323) 538-3630

WWW. BORROWEDEARTHCOLLABORATIVE.COM

INFO@ BORROWEDEARTHCOLLABORATIVE.COM

INTERIOR WALLS OVER WOOD OR METAL STUDS

Wood or Metal Studs • Cementitious-Coated Extruded Foam Backer Board • Natural Stone Tile

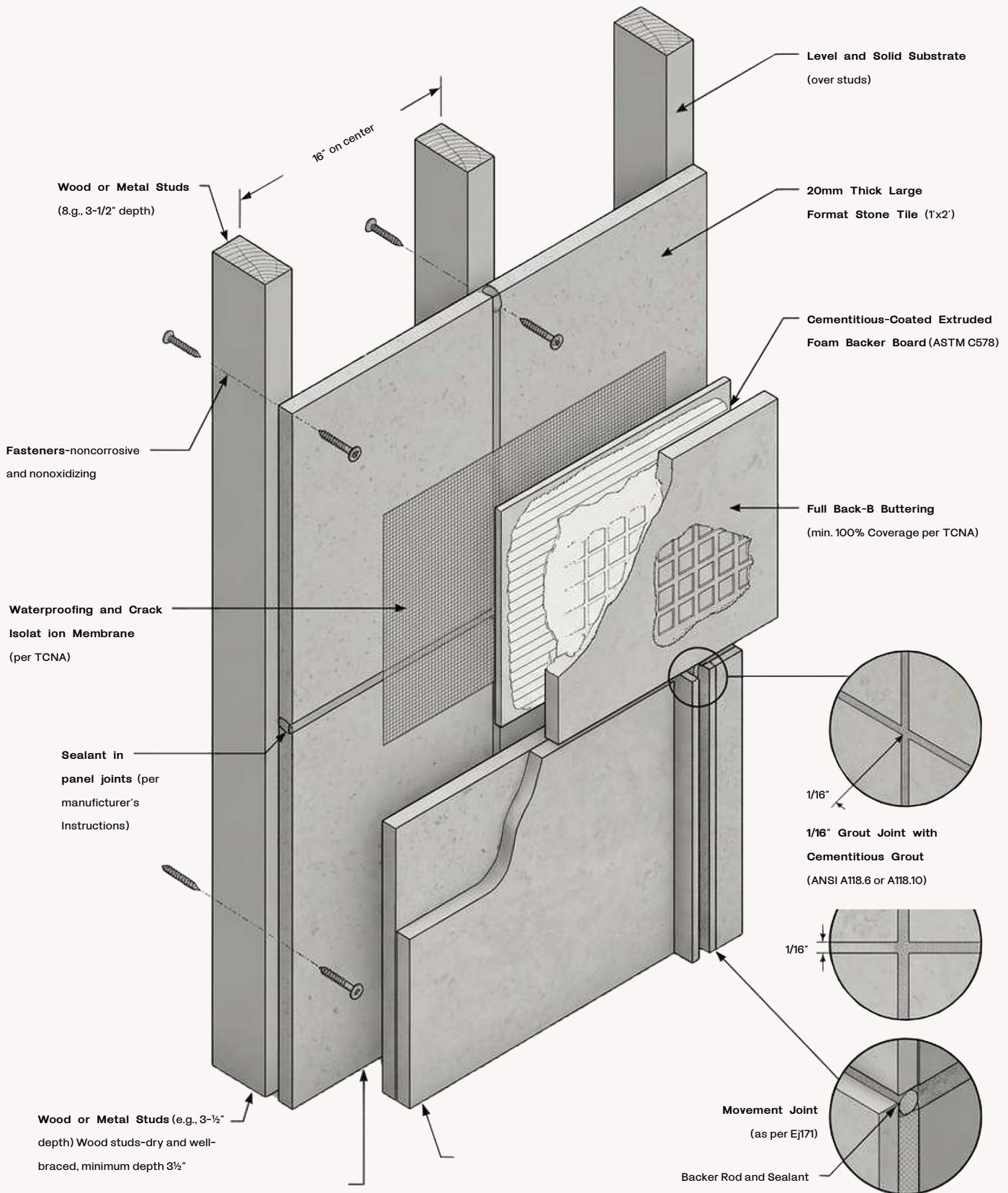

Source: 2019 Tile Council of North America

+1 (310) 341-6931

+1 (323) 538-3630

WWW. BORROWEDEARTHCOLLABORATIVE.COM

INFO@ BORROWEDEARTHCOLLABORATIVE.COM

INTERIOR WALLS OVER WOOD OR METAL STUDS

Wood or Metal Studs • Cement Backer Board • Spot-Bonding Epoxy • Natural Stone Tile

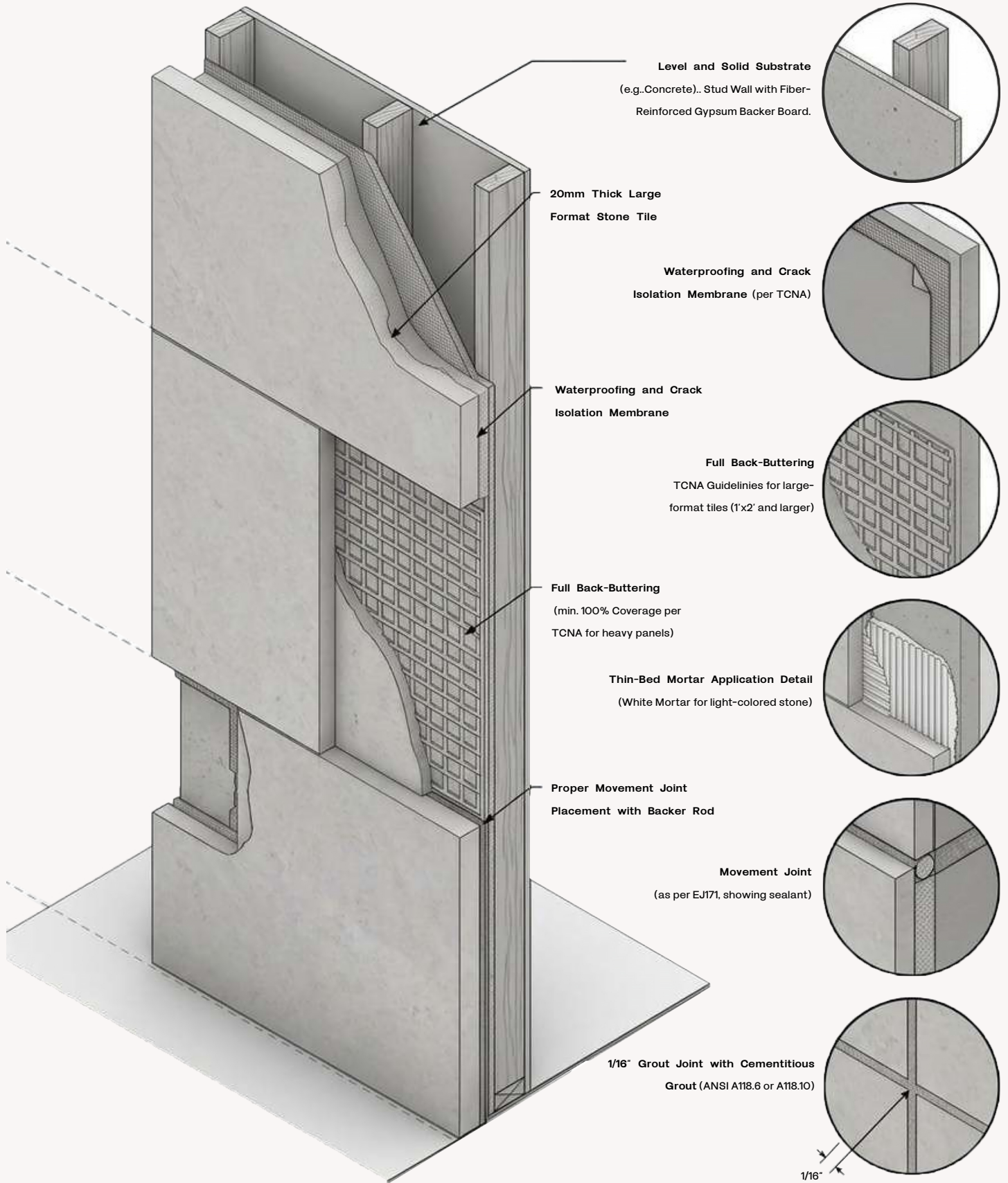

Source: 2019 Tile Council of North America

+1 (310) 341-6931

+1 (323) 538-3630

WWW. BORROWEDEARTHCOLLABORATIVE.COM

INFO@ BORROWEDEARTHCOLLABORATIVE.COM

INTERIOR WALLS OVER WOOD OR METAL STUDS

Wood or Metal Studs • Cement Backer Board • Spot-Bonding Epoxy • Natural Stone Tile

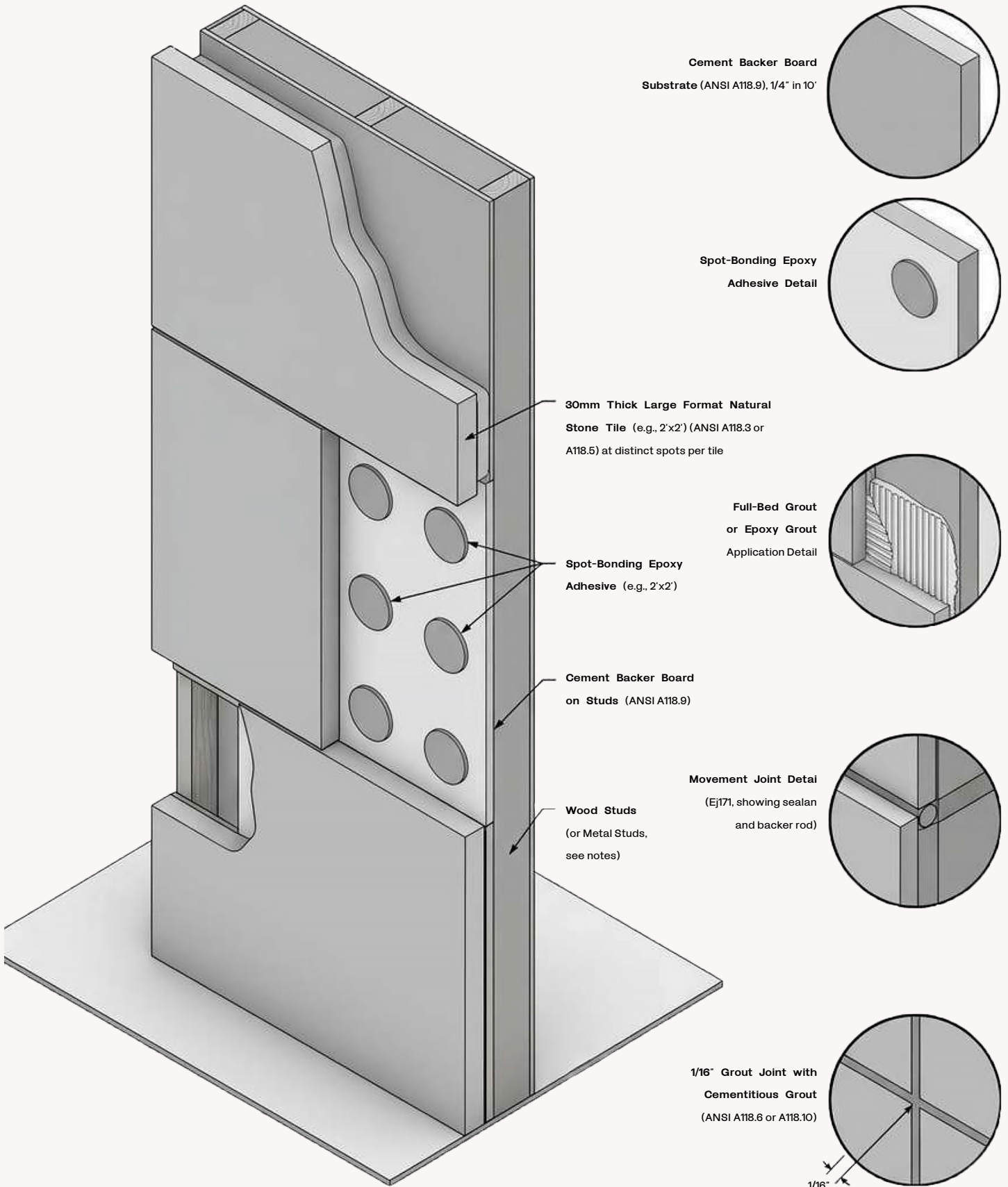

Source: 2019 Tile Council of North America

BATHTUB WALLS (NO SHOWERHEAD)

Gypsum Board or Glass Mat Gypsum Board • Natural Stone Tile

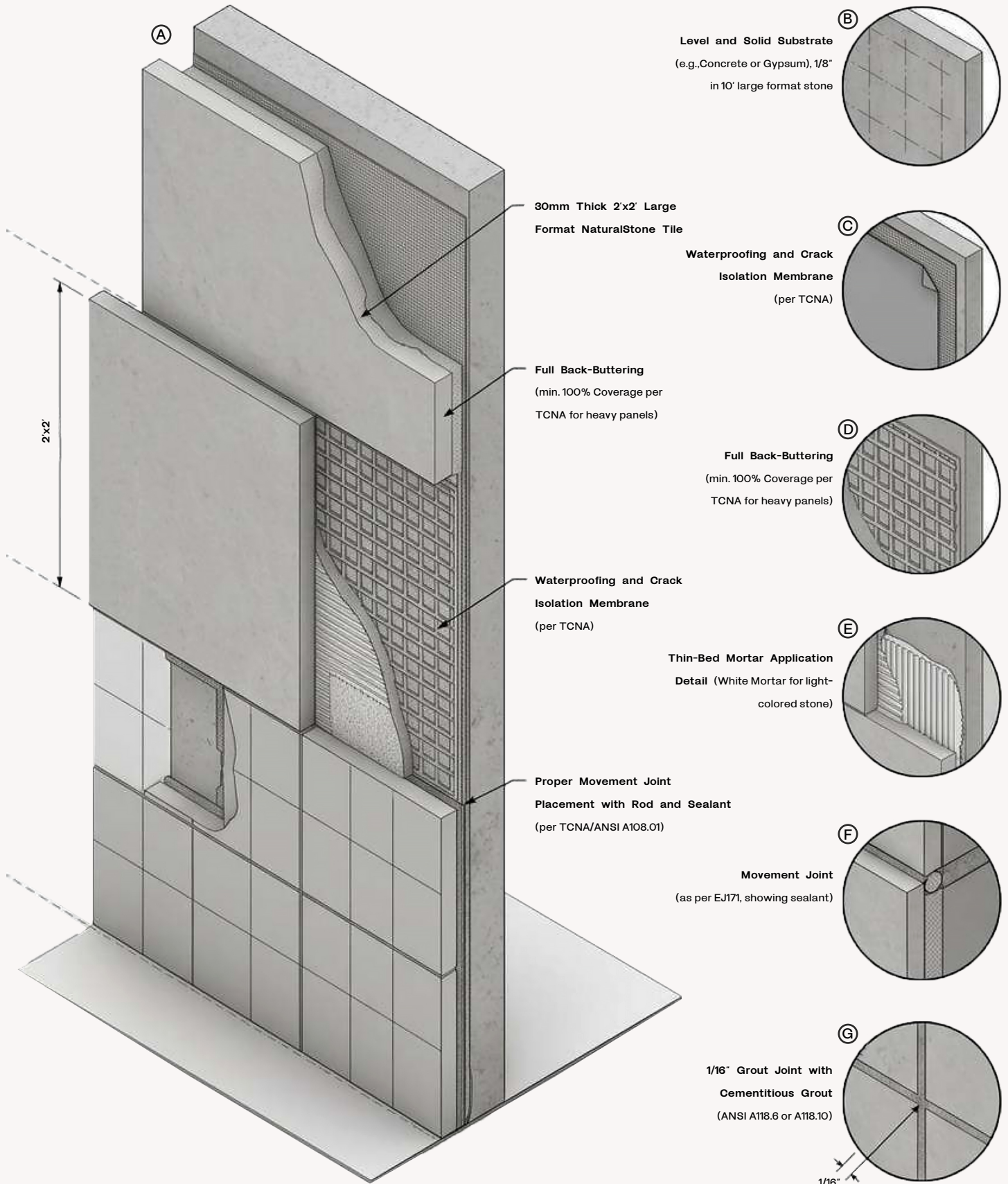

Source: 2019 Tile Council of North America

EXTERIOR WALLS

Masonry or Concrete • Bonded Mortar Bed • Natural Stone Tile

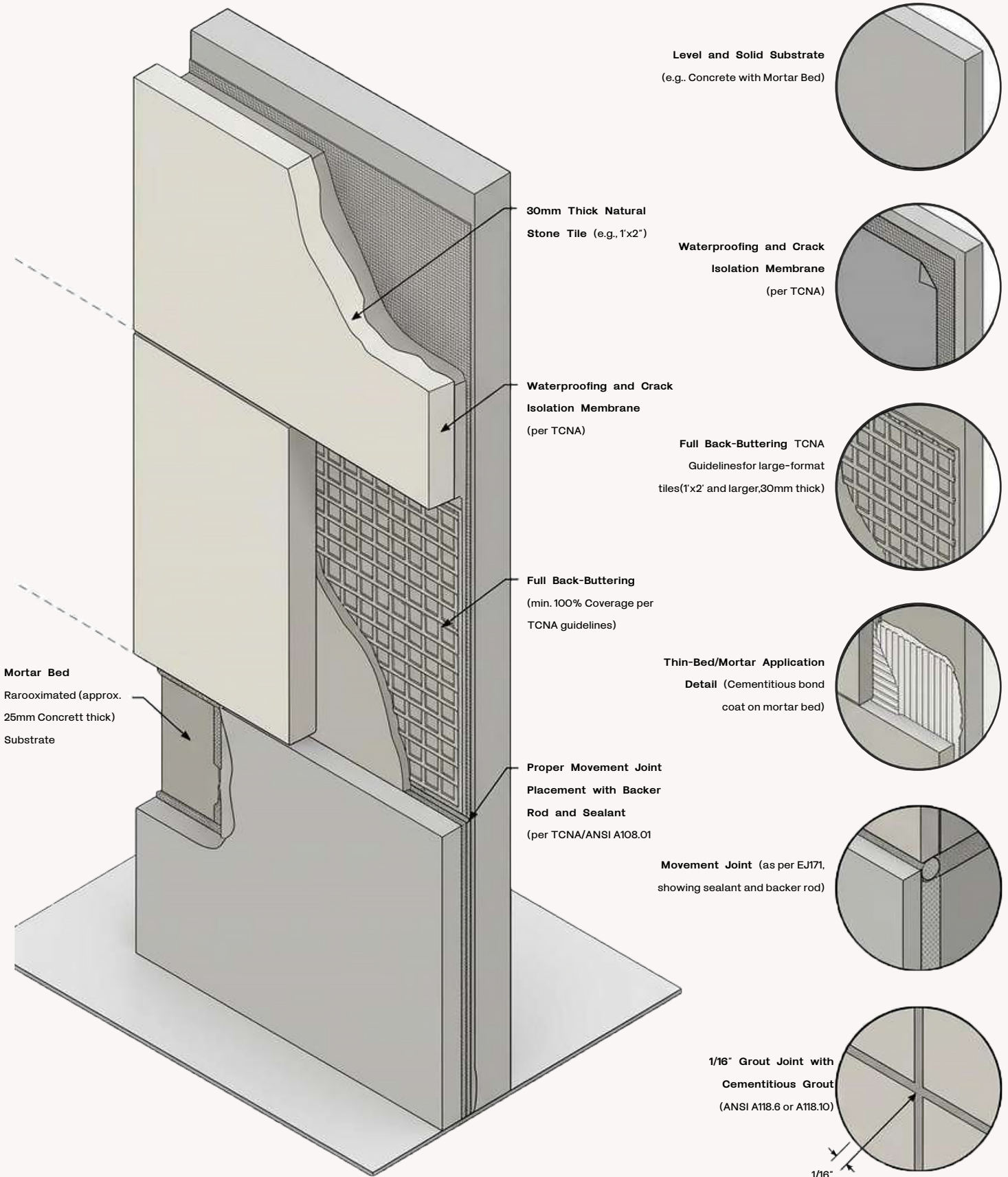

Source: 2019 Tile Council of North America

EXTERIOR WALLS

Masonry or Concrete • Natural Stone Tile

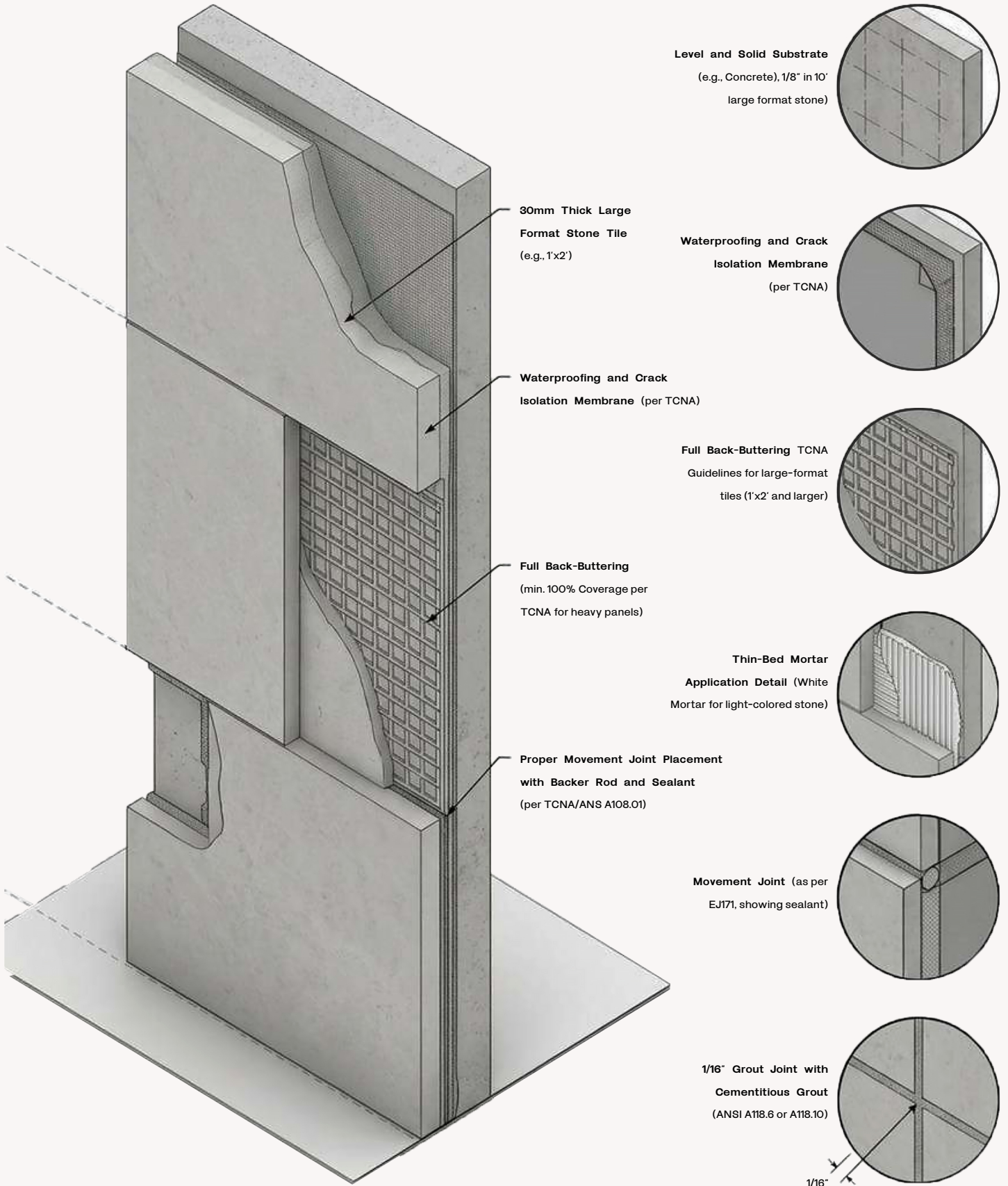

Source: 2019 Tile Council of North America

EXTERIOR WALLS

Wood or Metal Studs • Cement Backer Board • Natural Stone Tile

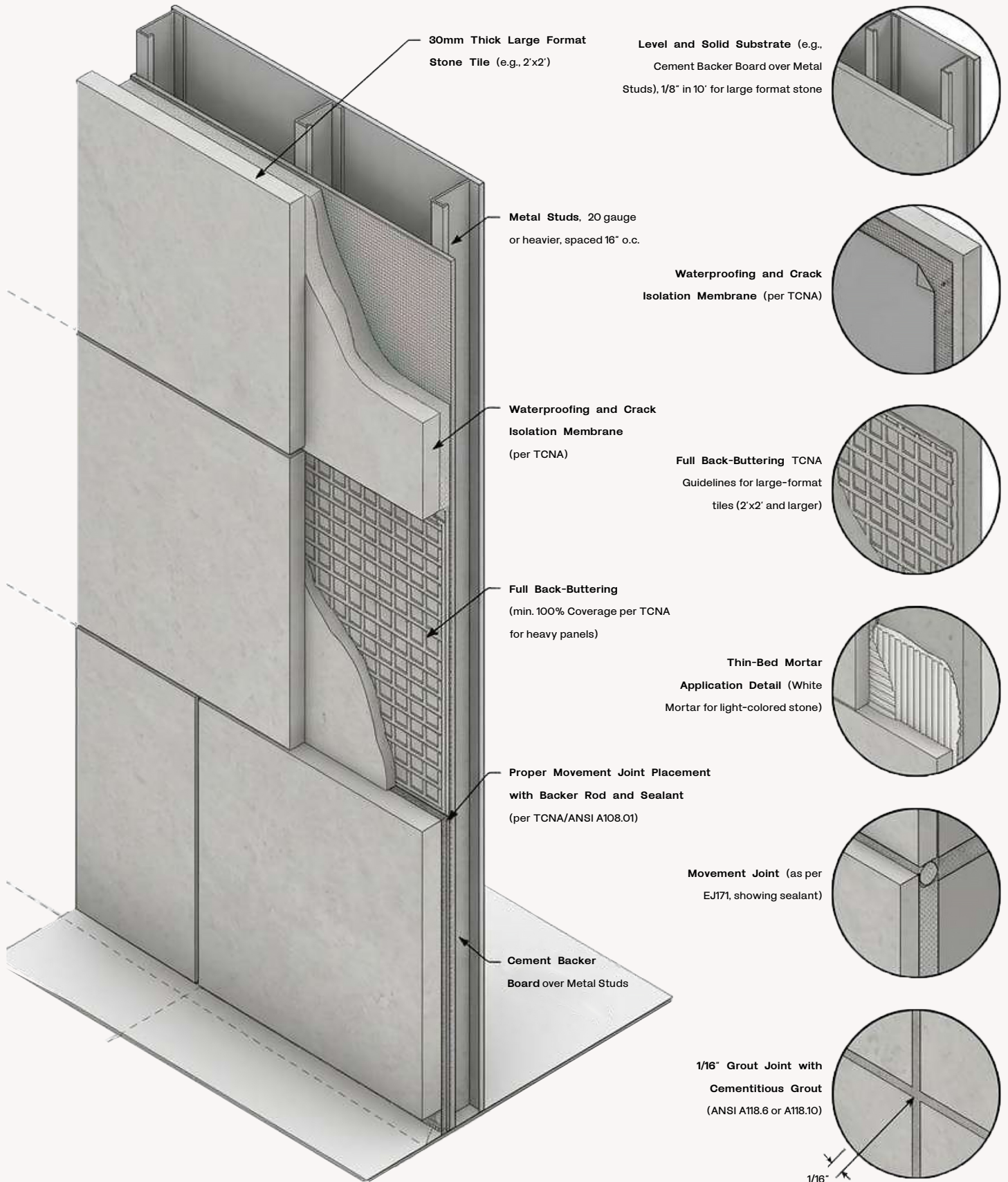

Source: 2019 Tile Council of North America

EXTERIOR WALLS

2"-4" thick stone Mechanical cladding

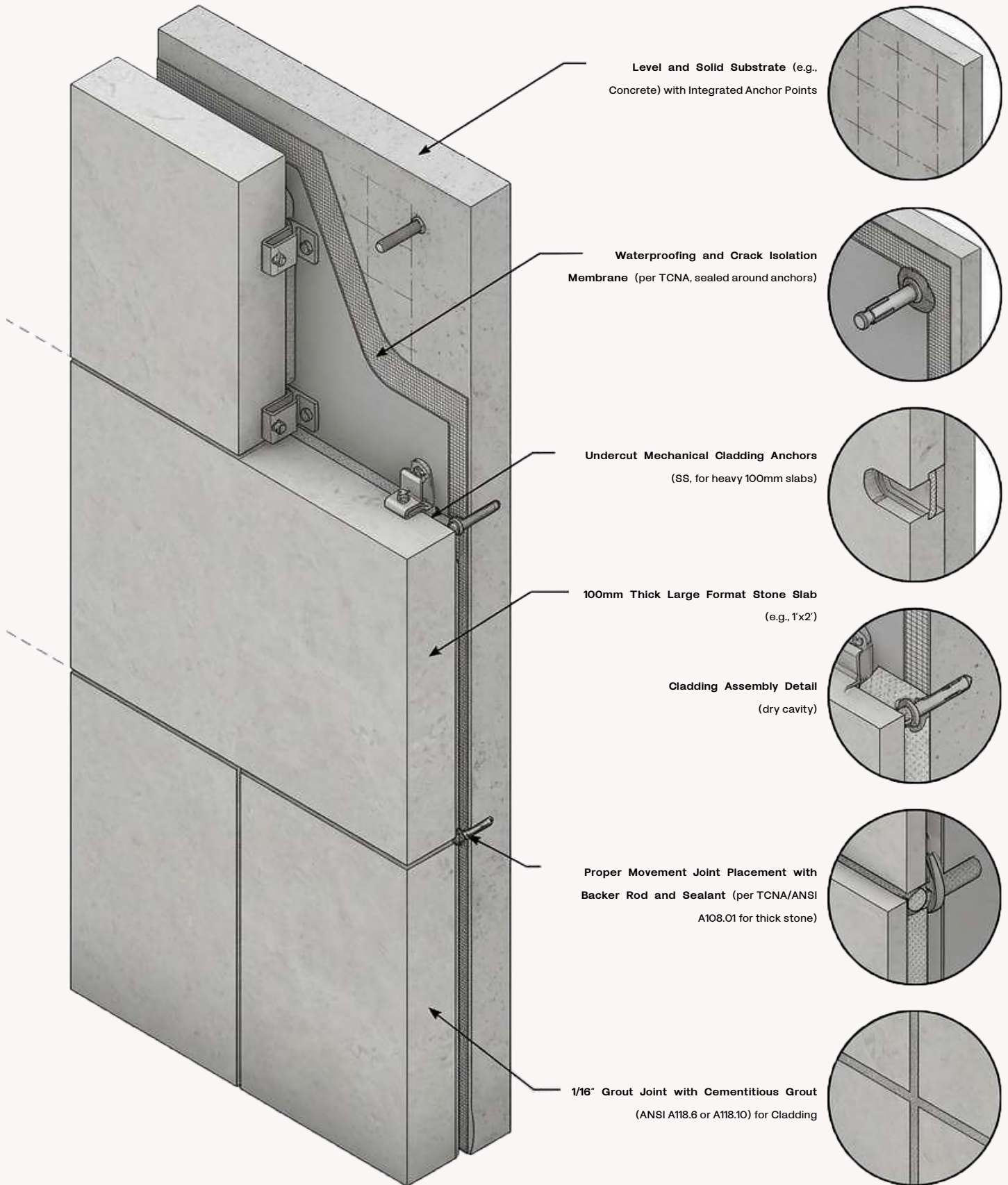

Source: 2019 Tile Council of North America

+1 (310) 341-6931

+1 (323) 538-3630

WWW. BORROWEDEARTHCOLLABORATIVE.COM

INFO@ BORROWEDEARTHCOLLABORATIVE.COM

DISCLAIMER – INSTALLATION GUIDELINES

The installation recommendations, details, drawings, and specifications provided by Borrowed Earth Collaborative (“Borrowed Earth”) are intended solely as general guidance based on typical industry practices and prior project experience. These guidelines are not exhaustive and are not a substitute for professional judgment, site-specific evaluation, or compliance with applicable laws and codes.

No Site-Specific Warranty

All project conditions—including but not limited to substrate quality, structural conditions, environmental exposure, load requirements, moisture presence, and adjacent materials—vary significantly by location and application. Borrowed Earth does not represent or warrant that these guidelines are appropriate for any specific project or site condition.

Responsibility of Project Team

It is the sole responsibility of the project owner, architect, contractor, installer, fabricator, and/or engineer of record to:

- Verify site conditions and dimensions prior to installation
- Ensure compatibility of Borrowed Earth products with the intended application and supporting systems
- Engage licensed professionals (including structural engineers, facade consultants, waterproofing specialists, and other relevant experts) as required
- Determine appropriate installation methods, anchoring systems, tolerances, and safety measures
- Ensure compliance with all applicable federal, state, and local building codes, regulations, ordinances, and standards, including but not limited to those set by authorities having ordinances, and standards, including but not limited to those set by authorities having jurisdiction (AHJ)

Jurisdictional Variations

Borrowed Earth products are used across multiple jurisdictions, including all 50 U.S. states, each of which may have different building codes, seismic requirements, wind load criteria, fire ratings, accessibility requirements, and permitting processes. It is the responsibility of the project team to ensure that all installations meet local code requirements and approval processes.

Third-Party Materials and Methods

Products is provided for convenience only. Borrowed Earth does not manufacture or control these materials and makes no warranties, express or implied, regarding their performance, suitability, or compatibility.

No Installation Liability

Borrowed Earth does not perform installation services and assumes no responsibility or liability for:

- Installation errors or improper workmanship
- Structural failure or performance issues related to installation systems
- Damage resulting from improper handling, storage, fabrication, or installation
- Failure to follow applicable codes, standards, or best practices

Natural Material Disclaimer

Borrowed Earth products are made from natural stone and are subject to inherent variations in color, veining, texture, fissures, and structural composition. These characteristics are not defects but are intrinsic to the material. Performance may vary based on stone type, thickness, finish, and application.

Limitation of Liability

To the fullest extent permitted by law, Borrowed Earth shall not be liable for any direct, indirect, incidental, consequential, or special damages, including but not limited to loss of use, project delays, cost of replacement, or labor costs, arising from the use of these guidelines or the installation of its products.

Final Approval

All drawings, shop drawings, engineering details, and installation methods must be reviewed and approved by the project's licensed professionals and relevant authorities prior to execution.